

SOLO GUARNIZIONE (OPZIONALE)
 ONLY SEAL (OPTIONAL)
 NUR DICHTUNG (OPTIONAL)
 cod. 0520013

KIT ADDUZIONE INTERNA (OPZIONALE)
 KIT FOR INTERNAL COOLANT (OPTIONAL)
 KIT FUER INTERNE KUEHLMITTELZUFUHR (OPTIONAL)
 Ø40 cod. KIT1003003
 Ø1 1/2" cod. KIT1003004

PER BOCCOLE DI RIDUZIONE VEDI PAG. TBL150-1-00
 FOR REDUCING BUSHINGS SEE PAGE TBL150-1-00
 FUER REDUZIERBUCHSE SIEHE SEITE TBL150-1-00

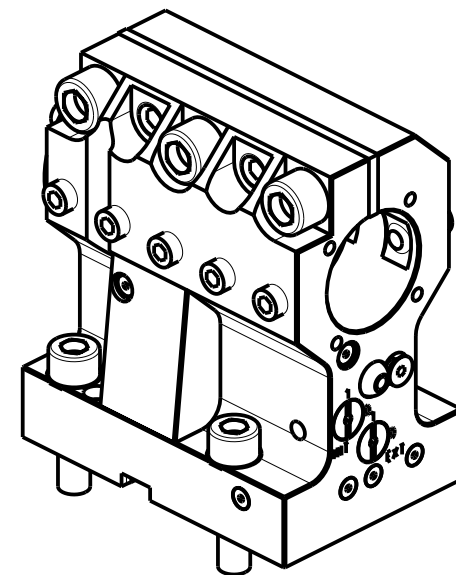

Cod. MT	N°Utensili N°Tools N°Werkzeuge	Lubrificazione int. opzionale Coolant through optional Innenkuehlung Optional	Lubrificazione est. Ext. coolant Aussenkuehlung	Reversibile lato mandrino/contromandrino Reversible sub/main spindle side Umkehrbare Spindel-seite/ Gegenspindel-seite	Misure Dimensions Masse	D
MNZ0154000	1	X	X	X	mm	40
MNZ0153810	1	X	X	X	Inch	1-1/2"

DMG-MORI

NZ1500/2000 - NZX1500/2000 - NZX2500 (BMT40) - NT3100/3150/3200 - NL1500/2000/2500 20 STAZ. - NLX1500/2000/2500 20 STAZ. - NTX500 (BMT40)
 NTX1000/2000/2500/3000 2ND GEN. 12ST. - DURATURN 2050MC/2550MC - ALC/ALX1500/2000/2500 (BMT40) - ECOTURN 450 (BMT40) - NZ DUE/TRE/QUATTRO (BMT40)

PORTAUTENSILE ASSIALE PER BARENO Ø40mm / Ø1 1/2" H=90mm

Axial single boring bar holder Ø40mm / Ø1 1/2" H=90mm

Axial Bohrhalter Ø40mm / Ø1 1/2" H=90mm

Subject to change without notice.

M.T. srl

Via Casino Albini 480

Tel. 0541/956034-957884

Fax 0541/956341

47842 S. GIOVANNI IN M. (RN)

e-mail: mtma@mtmarchetti.com

http://www.mtmarchetti.com



MNZ630-1-20

09/2024