

versione dx
right version
version rechts

versione sx
left version
version links

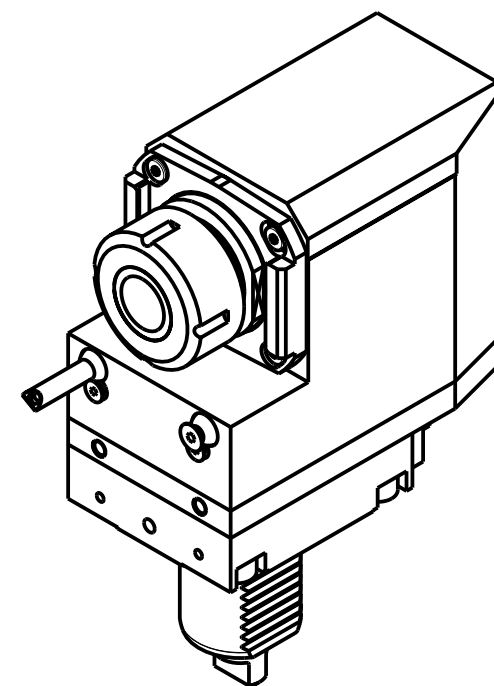
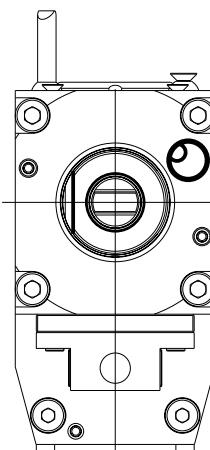
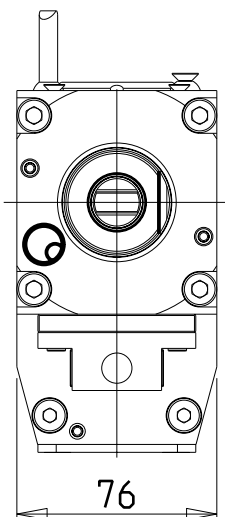

Cod. MT		Mandrino Spindle Spindel	I	RPM	Coppia Max Max Torque Max Drehmoment	Lubrificazione int. Coolant through Innenkuehlung	Lubrificazione est. Ext. coolant Aussenkuehlung	A	B	CHIAVI NON INCLUDE Keys not included Schluessel nicht einbegriffen	
versione dx right version version rechts	versione sx left version version links									CHSTER	MNZ0410005
DUP0220125	DUP0221125	ER25	1:1	6000	70Nm	-	X	42.66	95	CHSTER25	MNZ0410005 *
DUP0220225	DUP0221225	ER25	1:1	6000	70Nm	P=70bar	X	42.66	108.5	CHSTER25	MNZ0410005 *
DUP0220132	DUP0221132	ER32	1:1	6000	70Nm	-	X	45.66	95	CHSTER32	MNZ0410005 *
DUP0220232	DUP0221232	ER32	1:1	6000	70Nm	P=70bar	X	45.66	108.5	CHSTER32	MNZ0410005 *

- Chiave inclusa
- Key included
- Schluessel inbegriffen

DIPLOMATIC
VDI 40

MODULO MOTORIZZATO RADIALE ARRETRATO VDI40 H=100mm
Radial rear-set driven tool VDI40 H=100mm
Radial angetriebenes Werkzeug zurueckversetzt VDI40 H=100mm

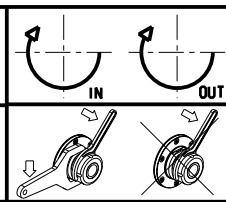

M.T. srl
Via Casino Albini 480
Tel. 0541/956034-957884
Fax 0541/956341
47842 S. GIOVANNI IN M. (RN)
e-mail: mtma@mtmarchetti.com
http://www.mtmarchetti.com



DUP013-2-10

Subject to change without notice.

09/2024