

ATTENZIONE - ATTENTION - ACHTUNG

- VERIFICARE LE MISURE DI INGOMBRO PER POSSIBILE INTERFERENZA SU ALCUNI MODELLI DI MACCHINE
- Please check the overall sizes for possible interferences on some machine models
- Bitte überprüfen sie das ausmass um mögliche interferenzen auf einigen maschinen modellen zu vermeiden

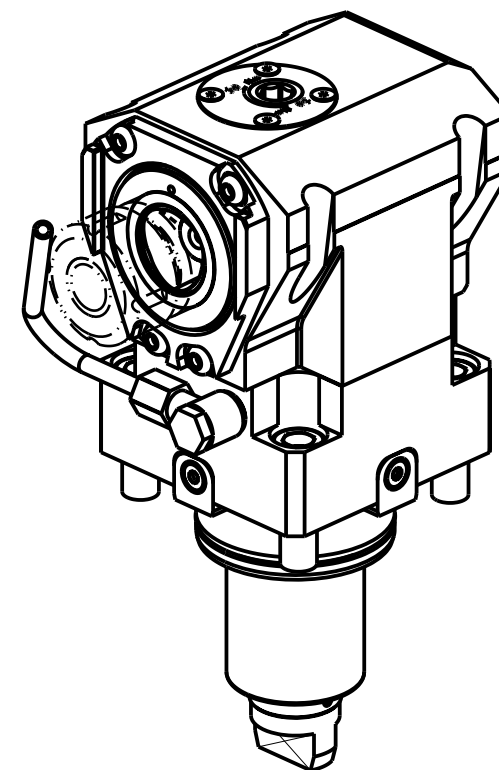
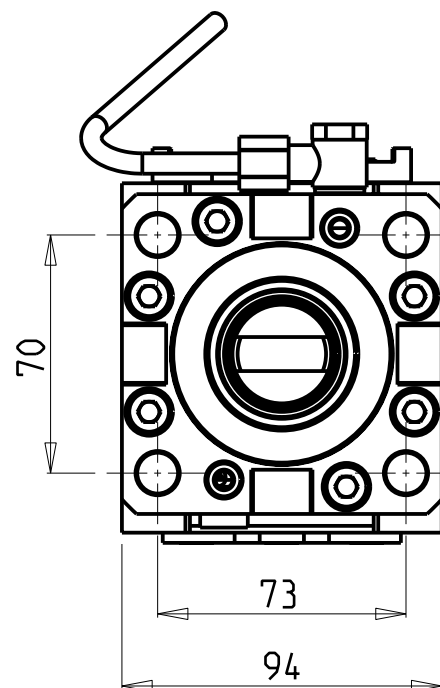
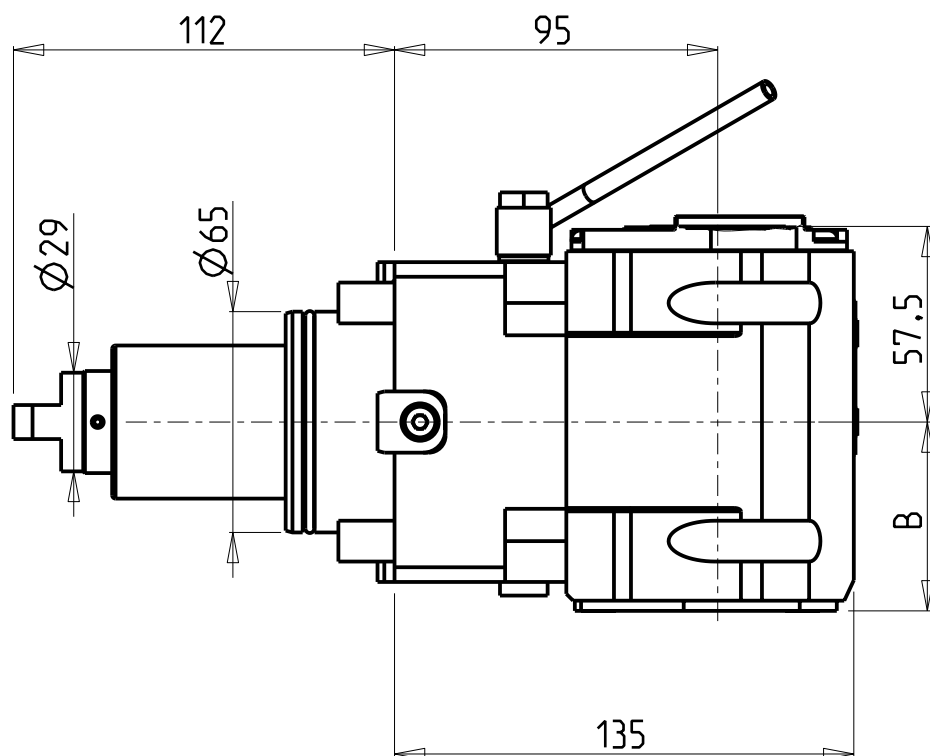

Cod. MT	TAGLIA Size Masse	I	RPM	Coppia Max Max Torque Max Drehmoment	Reversibile lato mandrino/contromandrino Reversible sub/main spindle side Umkehrbare Spindel-seite/ Gegenspindel-seite	Lubr.interna Coolant through Innenkuehlung	Lubr.esterna Ext. coolant Aussenkuehlung	B
DW03120140	C4	1:1	6000	100Nm	X	-	X	55.5
DW03120240	C4	1:1	6000	100Nm	X	P=70bar	X	66.5

GOODWAY

MOD: GTX2000/2600 12ST. - GTZ2000/2600 12ST. - GS2000/2800/3300 16ST. - GMT2000 - GMS2000 15ST.
GLS2800/3300 12ST. - GTH2000/2600 12ST.

MODULO MOTORIZZATO ASSIALE MT CAPTO H=95mm

Axial driven tool MT CAPTO H=95mm

Axial angetriebenes Werkzeug MT CAPTO H=95mm

Subject to change without notice.

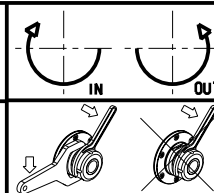

M.T. srl

Via Casino Albini 480
Tel. 0541/956034-957884
Fax 0541/956341
47842 S. GIOVANNI IN M. (RN)
e-mail: mtma@tmarchetti.com
http://www.tmmarchetti.com



GDW 150-D-42