

TORRETTE ASSIALI
AXIAL TURRETS
AXIAL REVOLVER

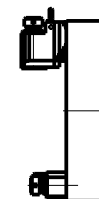

TORRETTE RADIALI
RADIAL TURRETS
RADIAL REVOLVER

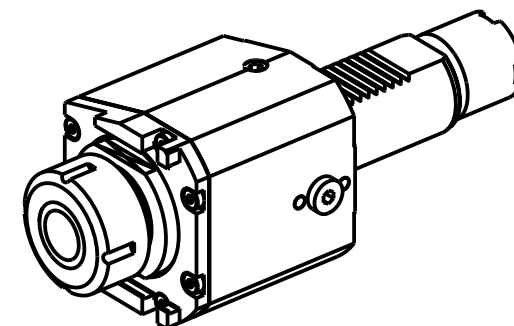

OKU1781232

OKU1781240

Cod. MT	Mandrino Spindle Spindel	I	RPM	Coppia Max Max Torque Max Drehmoment	Lubrificazione est. Ext. coolant Aussenkuehlung	Lubrificazione int. Coolant through Innenkuehlung	A	A1	CHIAVI NON INCLUSE Keys not included Schluessel nicht einbegriffen	
1220KU_A32_40B01	ER32	1:1	4000	70Nm	X	-	107.3	-	CHUB41	CHSTER32
OKU1781232	ER32	1:1	4000	70Nm	X	P=70bar	112.96	-	OKU0650004 •	CHSTER32
OKU1781240	ER40	1:1	4000	70Nm	X	P=70bar	115.96	-	OKU0650004 •	CHSTER40
1220KU_A32_40B11	WELDON 8	1:1	4000	70Nm	X	-	-	88.1	-	-
1220KU_A32_40B13	WELDON 12	1:1	4000	70Nm	X	-	-	92.6	-	-
1220KU_A32_40B15	WELDON 16	1:1	4000	70Nm	X	-	-	95.1	-	-

• Chiave inclusa

• Key included

• Schluessel inbegriffen

OKUMA

MOD: LB25/400 - LR25 - LU25M - LU400M

MODULO MOTORIZZATO ASSIALE VDI40

Axial driven tool VDI40

Axial angetriebenes Werkzeug VDI40

Subject to change without notice.

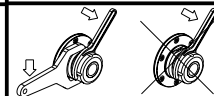
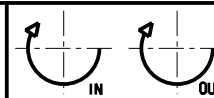

M.T. srl

Via Casino Albini 480
 Tel. 0541/956034-957884
 Fax 0541/956341
 47842 S. GIOVANNI IN M. (RN)
 e-mail: mtma@mtmarchetti.com
 http://www.mtmarchetti.com



OKU150-3-00

09/2024